

Tabletop Laser Controller

Type: ls11-la80v04-t12782-v2-389



- Laser max.: 80A, 4V
- trise-fall < 25us (optional < 5us)
- Supply Voltage: 90~230VAC - 50/60Hz
- External, Analog and Digital Modulation
- Internal Pulse Generator
- Pulses and Bursts internally and externally triggered
- Bias Current option
- Pilot Laser Supply
- External Fan Support
- Photo Diode Current Monitor max. 4mA
- Laser Current Monitor
- optional additional TEC-stages

Laser Connector

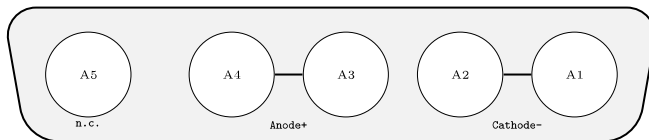

SubD-5W5 female

PIN.No	Abbr.	Function
A3; A4	LANO+	Laser Diode Anode (+)
A1; A2	LCAT-	Laser Diode Cathode (-)
A5	n.c.	

Support Connector

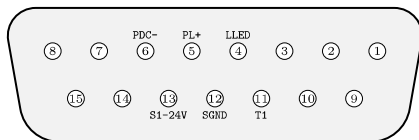

SubD-15 female

PIN.No	Abbr.	Function
4	LLED	Laser Active LED - Anode (+), 5V over 470R, v.s. GND
5	PL+	Pilot Laser (+), v.s. GND
6	PDC-	Photo Diode Cathode (-), v.s. GND
11	T1	Temperature Sensor 1 Input, default NTC10kΩ, v.s. GND
12	GND	Common Ground
13	1-24V	1 to 24V Supply, max. 800mA, vs. GND, supports fan etc.
	SCR	Common Screen

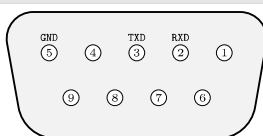
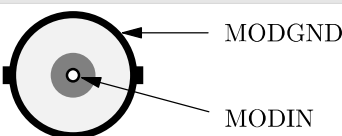
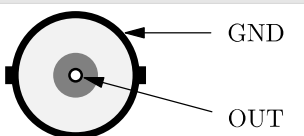
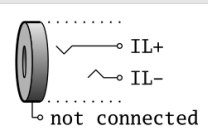
RS232 Connector	AMOD/DMOD-IN Connector	MOD-OUT Connector	Interlock Connector
			
<p>SubD-9 female Standard RS232-Connector 9600-Baud-8N1 (No Null-Modem Cable !)</p>	<p>BNC-Socket Input-Impdanz 10kOhm Digital Modulation with TTL-Pegel Analog Mod. 0-4[V] => 0-I_{max}[A]</p>	<p>BNC-Socket, current monitor 0-I_{max}[A] -> 0-4[V] Take care for laser isolation if you connect GND potential to an oscilloscope f.e.</p>	<p>Jack Connector 3.5mm Laser runs only if closed (ca. 5mA over 2V -> R <= 400R)</p>

Tabletop Laser Controller

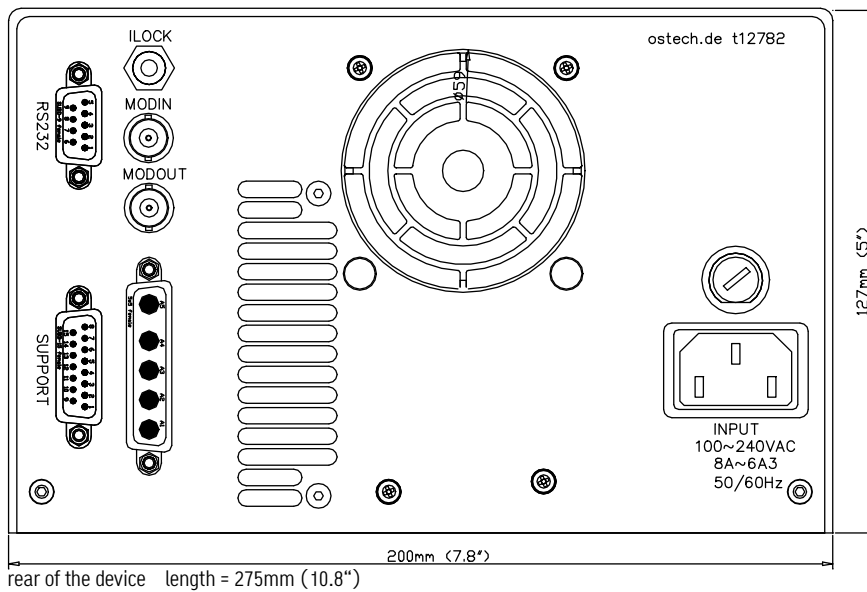

Revision overview:

2016.01.01: "v1" - New Power stage, Housing to 12782 and Temp. Sensor Interface
 2017.11.29: "v2" - Photo Diode max. Current increased to 4mA, maximum laser voltage reduced to 4V, MOD-OUT BNC-plug always at the panel

References:

<http://www.ostech.de/en/products/laser-drivers/ds11-t127>
<http://www.ostech.de/en/downloads/manuals/ds-en.pdf>
<http://www.ostech.de/en/downloads/labview>

Accessories

- acc-converter-usb-to-rs232-1m5-iso-417
RS232 to USB converter optical isolated with FTDI-Chip cable 1.5m
- kab-lpa08-16pol-subd15m-oe-1.5m-39
cable 16x0.35qmm / subd15-Gold-6,5A per pin to open end / length-1m5
- kab-la80-2x10qmm-5w5-oe-1.3m-141 / 2.5m- 657 / 5.0m- 660
cable 2x10qmm coaxial imax 80A SUBD-5W5 to open ends length 1m3 / 2m5 / 5m0